

## Basic Characteristics Data

Model	Circuit method	Switching frequency [kHz]	Input current *1 [A]	Inrush current protection	PCB/Pattern			Series/Parallel operation availability *2	
					Material	Single sided	Double sided	Series operation	Parallel operation
LFA10F	Flyback converter	100	0.26	LF	CEM-3	Yes		Yes	No
LFA15F	Flyback converter	100	0.35	Thermistor	CEM-3	Yes		Yes	No
LFA30F	Flyback converter	130	0.65	Thermistor	CEM-3	Yes		Yes	No
LFA50F	Active filter	60 ~ 440	0.67	Thermistor	CEM-3	Yes		Yes	No
	Flyback converter	130							
LFA75F	Active filter	60 ~ 440	1.0	Thermistor	CEM-3	Yes		Yes	No
	Flyback converter	130							
LFA100F	Active filter	60	1.3	Thermistor	CEM-3		Yes	Yes	No
	Forward converter	140							
LFA150F	Active filter	60	2.0	Thermistor	CEM-3		Yes	Yes	No
	Forward converter	140							
LFA240F	Active filter	60	3.3	SCR	CEM-3		Yes	Yes	No
	Forward converter	140							
LFA300F	Active filter	60	4.1	SCR	CEM-3		Yes	Yes	No
	Forward converter	140							

\*1 The value of input current is at ACIN 100V and rated load.

\*2 Refer to Instruction Manual 2.

<b>1</b>	<b>Function</b>	LFA-22
1.1	Input voltage range .....	LFA-22
1.2	Inrush current limiting .....	LFA-22
1.3	Overcurrent protection .....	LFA-22
1.4	Overvoltage protection .....	LFA-22
1.5	Output voltage adjustment range .....	LFA-22
1.6	Output ripple and ripple noise .....	LFA-23
1.7	Isolation .....	LFA-23
1.8	Reducing standby power .....	LFA-23
<b>2</b>	<b>Series Operation and Parallel Operation</b>	LFA-23
2.1	Series Operation .....	LFA-23
2.2	Parallel Operation .....	LFA-24
<b>3</b>	<b>Assembling and Installation Method</b>	LFA-24
3.1	Installation method .....	LFA-24
3.2	Derating .....	LFA-24
3.3	Mounting screw .....	LFA-28
3.4	Expectancy life and warranty .....	LFA-28
<b>4</b>	<b>Ground</b>	LFA-30
<b>5</b>	<b>Option and Others</b>	LFA-30
5.1	Outline of options .....	LFA-30
5.2	Others .....	LFA-32

# 1 Function

## 1.1 Input voltage range

**LFA**

- The range is from AC85V to AC264V or DC120V to DC370V (please see SPECIFICATIONS for details).
- In cases that conform with safety standard, input voltage range is AC100-AC240V (50/60Hz).
- If input value doesn't fall within above range, a unit may not operate in accordance with specifications and/or start hunting or fail. If you need to apply a square waveform input voltage, which is commonly used in UPS and inverters, please contact us.
- When the input voltage changes suddenly, the output voltage accuracy might exceed the specification. Please contact us.

### ● LFA10F, LFA15F, LFA30F

- A power factor improvement circuit (active filter) is not built-in. If you use multiple units for a single system, standards for input harmonic current may not be satisfied. Please contact us for details.

### ● LFA10F, LFA15F, LFA30F, LFA50F, LFA75F, LFA100F, LFA150F, LFA240F, LFA300F

- Operation stop voltage is set at a lower value than that of a standard version (derating is needed).
  - Use Conditions

	Output ( ) 3.3V	
LFA10F	5W	(3W)
LFA15F	7.5W	(5W)
LFA30F	10W	(7.5W)
LFA50F	15W	(10W)
LFA75F	25W	(15W)
LFA100F	30W	(20W)
LFA150F	50W	(30W)
LFA240F	80W	
LFA300F	100W	(75W)

Input AC50V or DC70V  
Duty 1s/30s

\*Please avoid using continuously for more than 1 second under above conditions. Doing so may cause a failure.

## 1.2 Inrush current limiting

- An inrush current limiting circuit is built-in.
- If you need to use a switch on the input side, please select one that can withstand an input inrush current.

### ● LFA10F

- Resistance for line filter is used for inrush current limiting.

### ● LFA15F, LFA30F, LFA50F, LFA75F, LFA100F, LFA150F

- Thermistor is used in the inrush current limiting circuit. When you turn the power ON/OFF repeatedly within a short period of time, please have enough intervals so that a power supply cools down before being turned on.

### ● LFA240F, LFA300F

- Thyristor technique is used in the inrush current limiting circuit. When you turn power ON/OFF repeatedly within a short period of time, please have enough intervals so that the inrush current limiting circuit becomes operative.
- When the switch of the input is turned on, the primary inrush current and secondary inrush current will be generated because the thyristor technique is used for the inrush current limiting circuit.

## 1.3 Overcurrent protection

- An overcurrent protection circuit is built-in and activated at 105% of the rated current or 101% of the peak current. A unit automatically recovers when a fault condition is removed. Please do not use a unit in short circuit and/or under an overcurrent condition.
- Intermittent Operation Mode  
Intermittent operation for overcurrent protection is included in a part of series. When the overcurrent protection circuit is activated and the output voltage drops to a certain extent, the output becomes intermittent so that the average current will also decrease.

## 1.4 Overvoltage protection

- An overvoltage protection circuit is built-in. If the overvoltage protection circuit is activated, shut down the input voltage, wait more than 3 minutes and turn on the AC input again to recover the output voltage. Recovery time varies depending on such factors as input voltage value at the time of the operation.
- In option -R2, overvoltage protection is removed by toggling ON/OFF signal of remote control.

#### Remarks :

Please avoid applying a voltage exceeding the rated voltage to an output terminal. Doing so may cause a power supply to malfunction or fail. If you cannot avoid doing so, for example, if you need to operate a motor, etc., please install an external diode on the output terminal to protect the unit.

## 1.5 Output voltage adjustment range

- Adjustment of output voltage is possible by using potentiometer. Please refer to instruction manual 5.1.
- Option "-Y" is recommended which can adjust the output voltage.

### 1.6 Output ripple and ripple noise

■ Output ripple noise may be influenced by measurement environment, measuring method fig.1.1 is recommended.

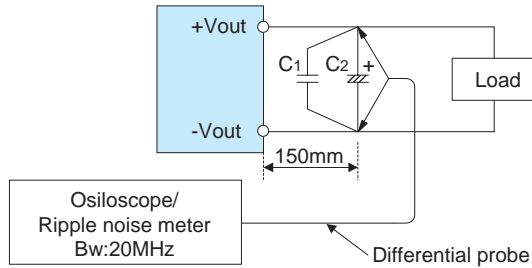

- C1 : Film capacitor 0.1 $\mu$ F
- C2 : Aluminum electrolytic capacitor 22 $\mu$ F

Fig.1.1 Measuring method of Ripple and Ripple Noise

**Remarks :**

When GND cable of probe with flux of magnetic force from power supply are crossing, ripple and ripple noise might not measure correctly.

Please note the measuring environment.

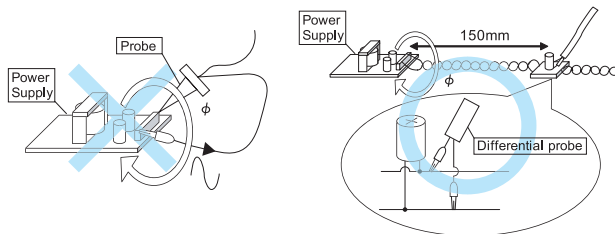

Bad example

Good example

Fig.1.2. Example of measuring output ripple and ripple noise

### 1.7 Isolation

■ For a receiving inspection, such as Hi-Pot test, gradually increase (decrease) the voltage for the start (shut down). Avoid using Hi-Pot tester with the timer because it may generate voltage a few times higher than the applied voltage, at ON/OFF of a timer.

### 1.8 Reducing standby power

● LFA10F, LFA15F

■ A circuit reducing standby power is built in LFA10F and LFA15F. (standby power : 0.5W typ)

The load factor:  $Io=0-35%$ , the internal switch element is intermittent operated, and the switching loss is decreased.

The specification of the Ripple/Ripple Noise changes by this intermittent operation. The value of the ripple/ripple Noise when intermittent operates changes in the input voltage and the output current.

Please contact us for details.

● LFA100F, LFA150F, LFA240F, LFA300F

■ As for option -R2, reducing standby power is possible by OFF signal of the remote control.

Please refer to instruction manual 5.1.

## 2 Series Operation and Parallel Operation

### 2.1 Series Operation

● LFA10F, LFA15F, LFA30F, LFA50F, LFA75F

■ Series operation is available by connecting the outputs of two or more power supplies with the same output voltage, as shown below. Output current in series connection should be lower than the lowest rated current in each unit.

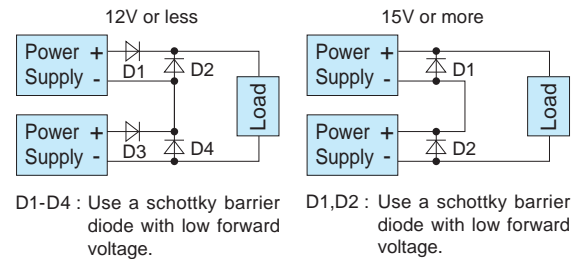

- D1-D4 : Use a schottky barrier diode with low forward voltage.
- D1,D2 : Use a schottky barrier diode with low forward voltage.

Fig.2.1 Examples of connecting in series operation (a)

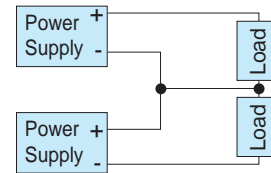
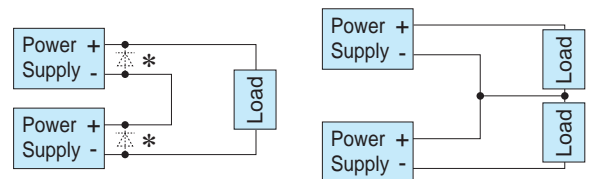

Fig.2.2 Examples of connecting in series operation (b)

● LFA100F, LFA150F, LFA240F, LFA300F

■ You can use a power supply in series operation. The output current in series operation should be lower than the rated current of a power supply with the lowest rated current among power supplies that are serially connected. Please make sure that no current exceeding the rated current flows into a power supply.



- \* Only LFA300F -3R3 and -5. Use a schottky barrier diode with low forward voltage.

(a) (b)

Fig.2.3 Examples of connecting in series operation

## 2.2 Parallel Operation

- Parallel operation is not possible.
- Redundancy operation is available by wiring as shown below.

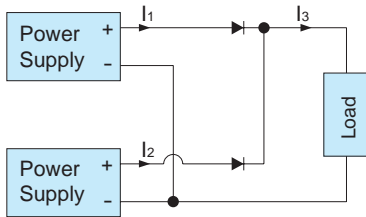

Fig.2.4 Example of redundancy operation

- Even a slight difference in output voltage can affect the balance between the values of  $I_1$  and  $I_2$ . Please make sure that the value of  $I_3$  does not exceed the rated current of a power supply.

$$I_3 \leq \text{the rated current value}$$

# 3 Assembling and Installation Method

## 3.1 Installation method

- This power supply is manufactured by SMD technology. The stress to P.C.B like twisting or bending causes the defect of the unit, so handle the unit with care.
- In case of metal chassis, keep the distance between  $d_1$  &  $d_2$  for to insulate between lead of component and metal chassis, use the spacer of 8mm or more between  $d_1$ . If it is less than  $d_1$  &  $d_2$ , insert the insulation sheet between power supply and metal chassis.

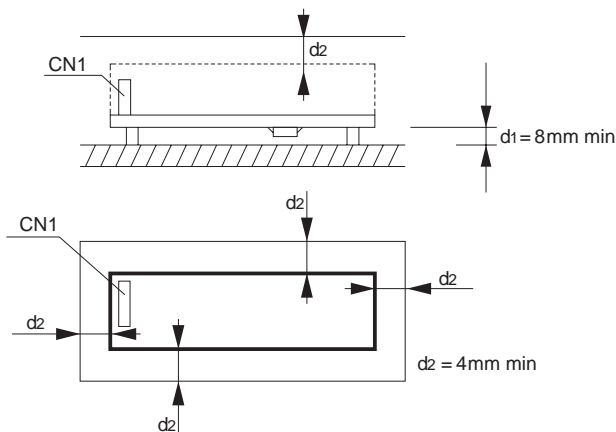

Fig.3.1 Installation method

- There is a possibility that it is not possible to cool enough when the power supply is used by the sealing up space as showing in Figure 3.2. Please use it after confirming the temperature of point A and point B of Instruction Manual 3.2.

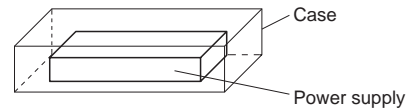

Fig.3.2 Installation example

## 3.2 Derating

- Environment to use it and Installation environment  
When using it, it is necessary to radiate heat by the heat of the power supply.  
Table 3.1 - 3.9 shows the relation between the upper limit temperature (Point A and Point B) and load factors.  
Please consider the ventilation so that the convection which is enough for the whole power supply is provided.  
And temperature of Point A and Point B please become lower than upper limit temperature.  
The expectancy life in the upper bound temperature (Point A and Point B) is three years or more.  
Please refer to External View for the position of Point A and Point B. In case of with Chassis and Cover, please contact our sales office for getting more information.

### Remarks:

- Please be careful of electric shock or earth leakage in case of temperature measurement, because Point A and Point B is live potential.
- Please refer to 3.4 if you want to extend the longevity of the expectancy life.

Table 3.1 Temperatures of Point A, Point B LFA10F-□

Mounting Method	Cooling Method	Load factor	Max temperature	
			Point A[°C]	Point B[°C]
A	Convection	20%<I <sub>o</sub> ≤100%	70	84
		I <sub>o</sub> ≤20%	75	79
B	Convection	20%<I <sub>o</sub> ≤100%	70	81
		I <sub>o</sub> ≤20%	73	77
C	Convection	20%<I <sub>o</sub> ≤100%	76	80
		I <sub>o</sub> ≤20%	76	77
D	Convection	20%<I <sub>o</sub> ≤100%	70	78
		I <sub>o</sub> ≤20%	75	77
E	Convection	20%<I <sub>o</sub> ≤100%	73	84
		I <sub>o</sub> ≤20%	76	79
F	Convection	20%<I <sub>o</sub> ≤100%	74	80
		I <sub>o</sub> ≤20%	76	78
A,B,C,D,E,F	Forced air	70%<I <sub>o</sub> ≤100%	75	75
		I <sub>o</sub> ≤70%	75	75

Table 3.2 Temperatures of Point A, Point B LFA15F-□

Mounting Method	Cooling Method	Load factor	Max temperature	
			Point A[°C]	Point B[°C]
A	Convection	40%<lo≤100%	72	80
		lo≤40%	77	81
B	Convection	40%<lo≤100%	68	73
		lo≤40%	74	78
C	Convection	40%<lo≤100%	75	84
		lo≤40%	78	81
D	Convection	40%<lo≤100%	71	77
		lo≤40%	76	79
E	Convection	40%<lo≤100%	70	79
		lo≤40%	76	81
F	Convection	40%<lo≤100%	71	78
		lo≤40%	76	80
A,B,C,D,E,F	Forced air	70%<lo≤100%	75	75
		lo≤70%	75	75

Table 3.3 Temperatures of Point A, Point B LFA30F-□

Mounting Method	Cooling Method	Load factor	Max temperature	
			Point A[°C]	Point B[°C]
A	Convection	70%<lo≤100%	73	73
		lo≤70%	79	77
B	Convection	60%<lo≤100%	73	74
		lo≤60%	80	82
C	Convection	70%<lo≤100%	80	77
		lo≤70%	83	80
D	Convection	70%<lo≤100%	72	70
		20%<lo≤70%	80	77
		lo≤20%	79	80
E	Convection	70%<lo≤100%	73	79
		20%<lo≤70%	79	85
F	Convection	70%<lo≤100%	73	75
		lo≤70%	79	79
A,B,C,D,E,F	Forced air	70%<lo≤100%	75	75
		lo≤70%	75	75

Table 3.4 Temperatures of Point A, Point B LFA50F-□

Mounting Method	Cooling Method	Load factor	Max temperature	
			Point A[°C]	Point B[°C]
A	Convection	70%<lo≤100%	86	68
		lo≤70%	86	77
B	Convection	70%<lo≤100%	72	65
		lo≤70%	77	70
C	Convection	50%<lo≤100%	78	71
		lo≤50%	84	77
D	Convection	50%<lo≤100%	83	68
		lo≤50%	85	72
E	Convection	50%<lo≤100%	76	75
		lo≤50%	83	81
F	Convection	50%<lo≤100%	80	78
		lo≤50%	84	76
A,B,C,D,E,F	Forced air	70%<lo≤100%	75	75
		lo≤70%	75	75

Table 3.5 Temperatures of Point A, Point B LFA75F-□

Mounting Method	Cooling Method	Load factor	Max temperature	
			Point A[°C]	Point B[°C]
A	Convection	70%<lo≤100%	85	70
		lo≤70%	86	76
B	Convection	70%<lo≤100%	77	65
		lo≤70%	81	71
C	Convection	70%<lo≤100%	81	68
		lo≤70%	83	72
D	Convection	70%<lo≤100%	78	58
		10%<lo≤70%	80	63
		lo≤10%	84	72
E	Convection	70%<lo≤100%	73	66
		10%<lo≤70%	83	68
		lo≤10%	83	79
F	Convection	70%<lo≤100%	74	59
		lo≤70%	83	71
A,B,C,D,E,F	Forced air	70%<lo≤100%	75	75
		lo≤70%	75	75

Table 3.6 Temperatures of Point A, Point B LFA100F-□

Mounting Method	Cooling Method	Load factor	Max temperature	
			Point A[°C]	Point B[°C]
A	Convection	70%<lo≤100%	85	74
		50%<lo≤70%	88	79
		lo≤50%	88	83
B	Convection	70%<lo≤100%	77	72
		50%<lo≤70%	87	82
		lo≤50%	88	86
C	Convection	70%<lo≤100%	87	82
		lo≤70%	88	85
D	Convection	70%<lo≤100%	80	70
		lo≤70%	85	80
E	Convection	70%<lo≤100%	74	85
		lo≤70%	80	88
F	Convection	70%<lo≤100%	79	71
		50%<lo≤70%	88	77
		lo≤50%	88	79
A,B,C,D,E,F	Forced air	70%<lo≤100%	75	75
		lo≤70%	75	75

Table 3.7 Temperatures of Point A, Point B LFA150F-□

Mounting Method	Cooling Method	Load factor	Max temperature	
			Point A[°C]	Point B[°C]
A	Convection	60%<lo≤100%	79	75
		20%<lo≤60%	86	85
		lo≤20%	87	87
B	Convection	70%<lo≤100%	75	70
		30%<lo≤70%	85	78
		lo≤30%	86	81
C	Convection	60%<lo≤100%	81	75
		30%<lo≤60%	86	81
		lo≤30%	87	83
D, F	Convection	70%<lo≤100%	73	67
		30%<lo≤70%	83	76
		lo≤30%	84	77
E	Convection	70%<lo≤100%	73	75
		30%<lo≤70%	82	83
		lo≤30%	83	84
A,B,C,D,E,F	Forced air	70%<lo≤100%	75	75
		lo≤70%	75	75

Table 3.8 Temperatures of Point A, Point B LFA240F-□

Mounting Method	Cooling Method	Load factor	Max temperature	
			Point A[°C]	Point B[°C]
A	Convection	75%<lo≤100%	75	70
		50%<lo≤75%	82	79
		lo≤50%	86	85
B	Convection	75%<lo≤100%	63	61
		50%<lo≤75%	73	73
		lo≤50%	81	83
C	Convection	75%<lo≤100%	76	73
		50%<lo≤75%	81	79
		lo≤50%	87	85
D	Convection	75%<lo≤100%	66	55
		50%<lo≤75%	74	65
		lo≤50%	84	78
E	Convection	75%<lo≤100%	62	62
		50%<lo≤75%	73	74
		lo≤50%	81	84
F	Convection	75%<lo≤100%	68	62
		50%<lo≤75%	77	73
		lo≤50%	84	83
A,B,C,D,E,F	Forced air	70%<lo≤100%	75	75
		lo≤70%	75	75

Table 3.9 Temperatures of Point A, Point B, Point C, Point D LFA300F-□

Mounting Method	Cooling Method	Load factor	Max temperature			
			Point A[°C]	Point B[°C]	Point C[°C]	Point D[°C]
A	Convection	80%<lo≤100%	70	86		
		60%<lo≤80%	75	88		
		lo≤60%	79	89		
B	Convection	80%<lo≤100%	57	68		
		60%<lo≤80%	62	71		
		lo≤60%	71	79		
C	Convection	80%<lo≤100%	69	75		
		60%<lo≤80%	74	75		
		lo≤60%	83	82		
D	Convection	80%<lo≤100%	58	62		
		60%<lo≤80%	64	66		
		lo≤60%	75	75		
E	Convection	80%<lo≤100%	57	80		
		60%<lo≤80%	63	83		
		lo≤60%	74	88		
F	Convection	80%<lo≤100%	61	68		
		60%<lo≤80%	68	71		
		lo≤60%	76	80		
A,B,C,D,E and F (3.3V/5V/12V/15V)	Forced air	50%<lo≤100%	75	75	85	85
		lo≤50%	75	75	85	85
A,B,C,D,E and F (24V/30V/36V/48V)	Forced air	50%<lo≤100%	75	75	85	85
		lo≤50%	75	75	85	85

■ The operative ambient temperature is different by with / without chassis cover or mounting position. Derating curve is shown below.  
 Note: In the hatched area, the specification of Ripple, Ripple Noise is different from other area.

### LFA10F

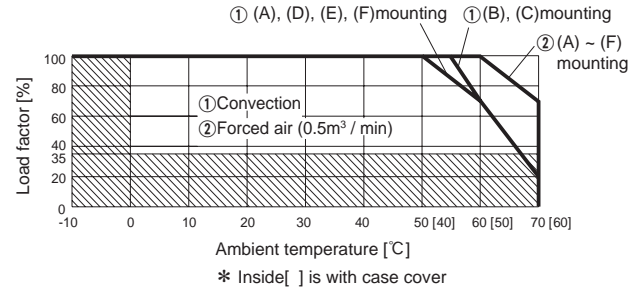

Fig.3.3 Ambient temperature derating curve (refer to Table 3.1)

### LFA15F

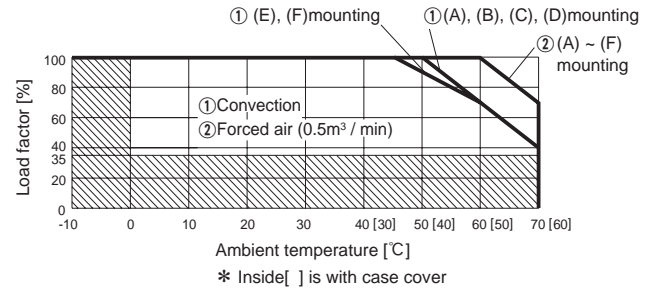

Fig.3.4 Ambient temperature derating curve (refer to Table 3.2)

### LFA30F

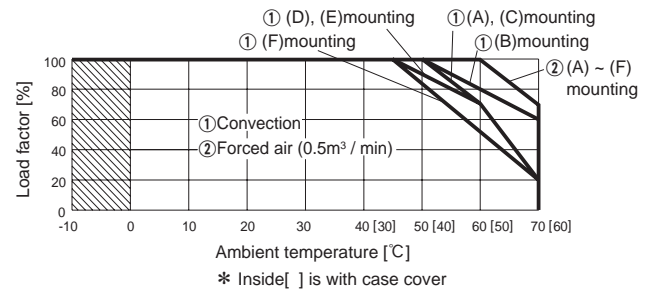

Fig.3.5 Ambient temperature derating curve (refer to Table 3.3)

### LFA50F

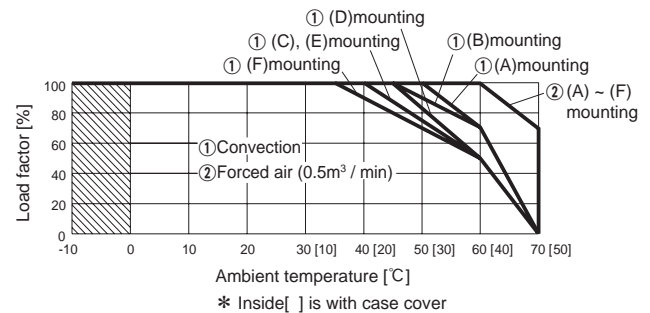

Fig.3.6 Ambient temperature derating curve (refer to Table 3.4)

● LFA75F

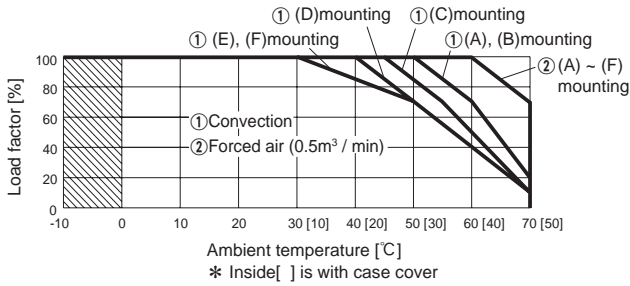

Fig.3.7 Ambient temperature derating curve (refer to Table 3.5)

● LFA100F

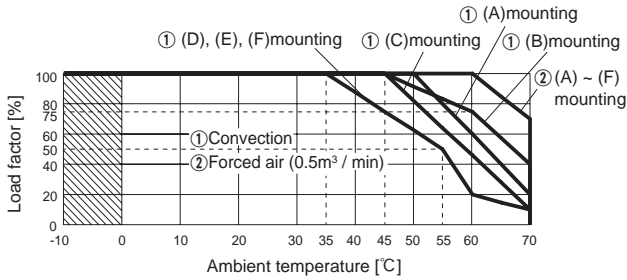

Fig.3.8 Ambient temperature derating curve (refer to Table 3.6)

● LFA100F-□-SN

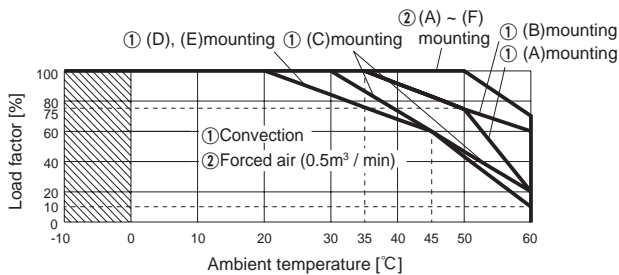

Fig.3.9 Ambient temperature derating curve

● LFA150F

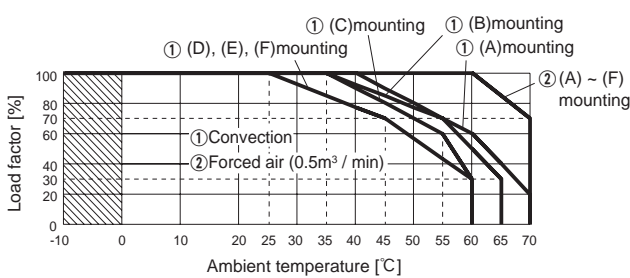

Fig.3.10 Ambient temperature derating curve (refer to Table 3.7)

● LFA150F-□-SN

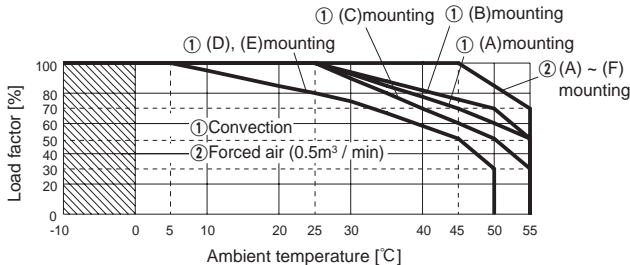

Fig.3.11 Ambient temperature derating curve

● LFA240F

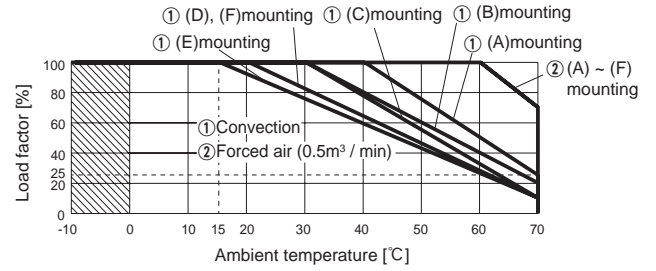

Fig.3.12 Ambient temperature derating curve (refer to Table 3.8)

● LFA240F-□-SN

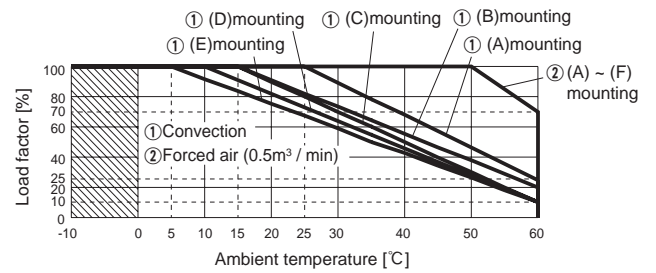
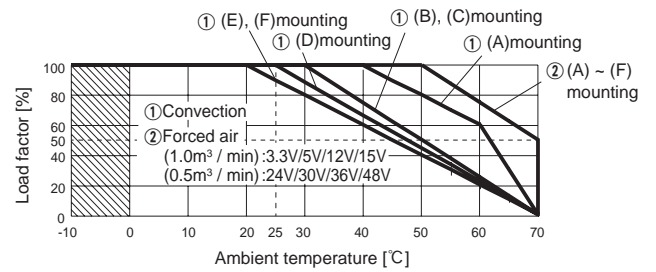

Fig.3.13 Ambient temperature derating curve

● LFA300F



Output voltage	Output power[W]	
	①Convection	②Forced air
3.3V	132.0	198.0
5V	200.0	300.0
12V	204.0	324.0
15V	210.0	330.0
24V	300.0	336.0
30V	300.0	330.0
36V	302.4	338.4
48V	302.4	336.0

Fig.3.14 Ambient temperature derating curve (refer to Table 3.9)



Derating curve depending on input voltage

Derating curve depending on input voltage is shown in Fig.3.8.

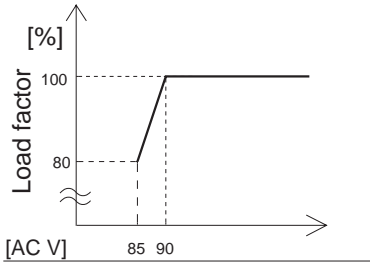

Fig.3.17 Derating curve depending on input voltage

Mounting method

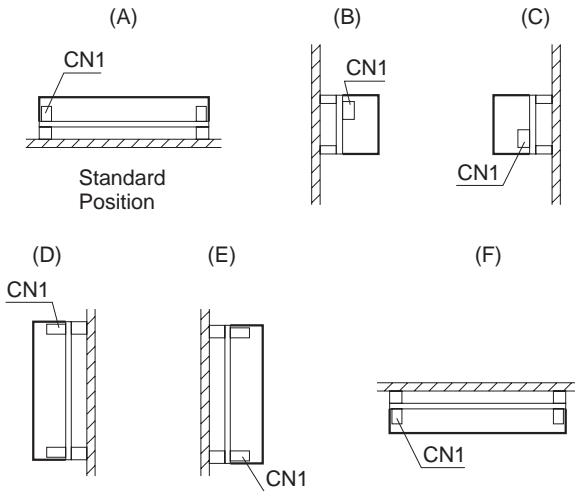

Fig.3.18 Mounting method

(F) mounting is not possible when unit is with case cover, but if need to operate unit by (F) positioning with case cover, temperature / load derating is necessary. For more details, please contact our sales or engineering departments.

3.3 Mounting screw

The mounting screw should be M3. The hatched area shows the allowance of metal parts for mounting.

If metallic fittings are used on the component side of the board, ensure there is no contact with surface mounted components.

This product uses SMD technology.

Please avoid the PCB installation method which includes the twisting stress or the bending stress.

\*Recommendation to electrically connect FG to metal chassis for reducing noise.

LFA10F, LFA15F

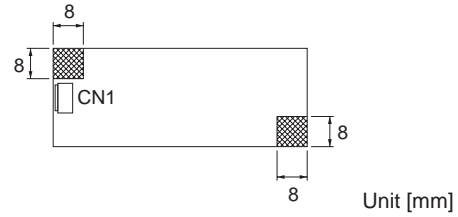

Fig.3.19 Allowance of metal parts for mounting (LFA10F, LFA15F)

LFA30F, LFA50F, LFA75F, LFA100F, LFA150F

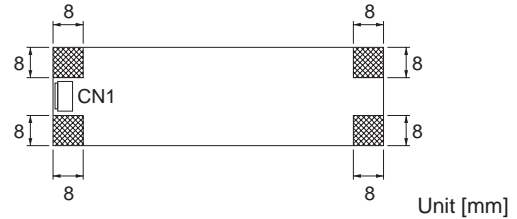

Fig.3.20 Allowance of metal parts for mounting (LFA30F, LFA50F, LFA75F, LFA100F, LFA150F)

LFA240F, LFA300F

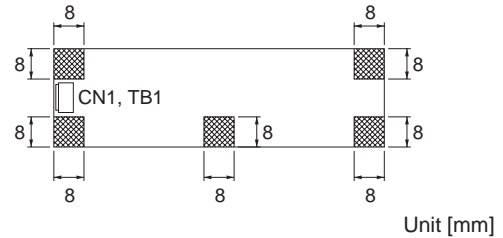

Fig.3.21 Allowance of metal parts for mounting (LFA240F, LFA300F)

3.4 Expectancy life and warranty

Expectancy Life.

Table 3.10 Expectancy Life (LFA10F-□)

Mounting Method	Cooling Method	Average ambient temperature (year)	Expectancy Life	
			lo ≤ 75%	75% < lo ≤ 100%
A, D, E, F	Convection	Ta = 40°C or less	6years	6years
		Ta = 50°C	5years	3years
B, C	Convection	Ta = 45°C or less	6years	6years
		Ta = 55°C	5years	3years
A,B,C,D,E,F	Forced air	Ta = 60°C	5years	3years

Table 3.11 Expectancy Life (LFA15F-□)

Mounting Method	Cooling Method	Average ambient temperature (year)	Expectancy Life	
			lo ≤ 75%	75% < lo ≤ 100%
A, B, C, D	Convection	Ta = 40°C or less	6years	6years
		Ta = 50°C	5years	3years
E, F	Convection	Ta = 35°C or less	6years	6years
		Ta = 45°C	5years	3years
A,B,C,D,E,F	Forced air	Ta = 60°C	5years	3years

Table 3.12 Expectancy Life (LFA30F-□)

Mounting Method	Cooling Method	Average ambient temperature (year)	Expectancy Life	
			Io ≤ 75%	75% < Io ≤ 100%
A, B, C	Convection	Ta = 40°C or less	6years	6years
		Ta = 50°C	5years	3years
D, E, F	Convection	Ta = 35°C or less	6years	6years
		Ta = 45°C	5years	3years
A,B,C,D,E,F	Forced air	Ta = 60°C	5years	3years

Table 3.13 Expectancy Life (LFA50F-□)

Mounting Method	Cooling Method	Average ambient temperature (year)	Expectancy Life	
			Io ≤ 75%	75% < Io ≤ 100%
A	Convection	Ta = 40°C or less	6years	6years
		Ta = 50°C	5years	3years
B, D	Convection	Ta = 35°C or less	6years	6years
		Ta = 45°C	5years	3years
C, E	Convection	Ta = 30°C or less	6years	6years
		Ta = 40°C	5years	3years
F	Convection	Ta = 25°C or less	6years	6years
		Ta = 35°C	5years	3years
A,B,C,D,E,F	Forced air	Ta = 60°C	5years	3years

Table 3.14 Expectancy Life (LFA75F-□)

Mounting Method	Cooling Method	Average ambient temperature (year)	Expectancy Life	
			Io ≤ 75%	75% < Io ≤ 100%
A, B	Convection	Ta = 40°C or less	6years	6years
		Ta = 50°C	5years	3years
C	Convection	Ta = 35°C or less	6years	6years
		Ta = 45°C	5years	3years
D	Convection	Ta = 30°C or less	6years	6years
		Ta = 40°C	5years	3years
E, F	Convection	Ta = 20°C or less	6years	6years
		Ta = 30°C	5years	3years
A,B,C,D,E,F	Forced air	Ta = 60°C	5years	3years

Table 3.15 Expectancy Life (LFA100F-□)

Mounting Method	Cooling Method	Average ambient temperature (year)	Expectancy Life	
			Io ≤ 75%	75% < Io ≤ 100%
A	Convection	Ta = 40°C or less	6years	6years
		Ta = 50°C	5years	3years
B, C	Convection	Ta = 35°C or less	6years	6years
		Ta = 45°C	5years	3years
D, E, F	Convection	Ta = 35°C or less	6years	6years
		Ta = 45°C	5years	3years
A,B,C,D,E,F	Forced air	Ta = 60°C	5years	3years

Table 3.16 Expectancy Life (LFA150F-□)

Mounting Method	Cooling Method	Average ambient temperature (year)	Expectancy Life	
			Io ≤ 75%	75% < Io ≤ 100%
A	Convection	Ta = 30°C or less	6years	6years
		Ta = 40°C	6years	5years
B	Convection	Ta = 25°C or less	6years	6years
		Ta = 35°C	6years	6years
C	Convection	Ta = 25°C or less	6years	6years
		Ta = 35°C	6years	5years
D, F	Convection	Ta = 25°C or less	6years	6years
E	Convection	Ta = 25°C or less	6years	5years
A,B,C,D,E,F	Forced air	Ta = 60°C	5years	5years

Table 3.17 Expectancy Life (LFA240F-□)

Mounting Method	Cooling Method	Average ambient temperature (year)	Expectancy Life	
			Io ≤ 75%	75% < Io ≤ 100%
A	Convection	Ta = 30°C or less	6years	6years
		Ta = 40°C	5years	3years
B, C	Convection	Ta = 20°C or less	6years	6years
		Ta = 30°C	5years	3years
D, F	Convection	Ta = 20°C or less	6years	5years
E	Convection	Ta = 15°C or less	6years	5years
A,B,C,D,E,F	Forced air	Ta = 60°C	5years	3years

Table 3.18 Expectancy Life (LFA300F-□)

Mounting Method	Cooling Method	Average ambient temperature (year)	Expectancy Life	
			Io ≤ 75%	75% < Io ≤ 100%
A	Convection	Ta = 30°C or less	6years	6years
		Ta = 40°C	5years	3years
B, C	Convection	Ta = 20°C or less	6years	6years
		Ta = 30°C	5years	3years
D	Convection	Ta = 25°C or less	6years	5years
E, F	Convection	Ta = 20°C or less	6years	5years
A,B,C,D,E,F	Forced air	Ta = 50°C	5years	3years

■ Warranty

Table 3.19 Warranty (LFA10F-□)

Mounting Method	Cooling Method	Average ambient temperature (year)	Warranty	
			Io ≤ 75%	75% < Io ≤ 100%
A, D, E, F	Convection	Ta = 40°C or less	5years	5years
		Ta = 50°C	5years	3years
B, C	Convection	Ta = 45°C or less	5years	5years
		Ta = 55°C	5years	3years
A,B,C,D,E,F	Forced air	Ta = 60°C	5years	3years

Table 3.20 Warranty (LFA15F-□)

Mounting Method	Cooling Method	Average ambient temperature (year)	Warranty	
			Io ≤ 75%	75% < Io ≤ 100%
A, B, C, D	Convection	Ta = 40°C or less	5years	5years
		Ta = 50°C	5years	3years
E, F	Convection	Ta = 35°C or less	5years	5years
		Ta = 45°C	5years	3years
A,B,C,D,E,F	Forced air	Ta = 60°C	5years	3years

Table 3.21 Warranty (LFA30F-□)

Mounting Method	Cooling Method	Average ambient temperature (year)	Warranty	
			Io ≤ 75%	75% < Io ≤ 100%
A, B, C	Convection	Ta = 40°C or less	5years	5years
		Ta = 50°C	5years	3years
D, E, F	Convection	Ta = 35°C or less	5years	5years
		Ta = 45°C	5years	3years
A,B,C,D,E,F	Forced air	Ta = 60°C	5years	3years

Table 3.22 Warranty (LFA50F-□)

Mounting Method	Cooling Method	Average ambient temperature (year)	Warranty	
			Io ≤ 75%	75% < Io ≤ 100%
A	Convection	Ta = 40°C or less	5years	5years
		Ta = 50°C	5years	3years
B, D	Convection	Ta = 35°C or less	5years	5years
		Ta = 45°C	5years	3years
C, E	Convection	Ta = 30°C or less	5years	5years
		Ta = 40°C	5years	3years
F	Convection	Ta = 25°C or less	5years	5years
		Ta = 35°C	5years	3years
A,B,C,D,E,F	Forced air	Ta = 60°C	5years	3years

Table 3.23 Warranty (LFA75F-□)

Mounting Method	Cooling Method	Average ambient temperature (year)	Warranty	
			Io ≤ 75%	75% < Io ≤ 100%
A, B	Convection	Ta = 40°C or less	5years	5years
		Ta = 50°C	5years	3years
C	Convection	Ta = 35°C or less	5years	5years
		Ta = 45°C	5years	3years
D	Convection	Ta = 30°C or less	5years	5years
		Ta = 40°C	5years	3years
E, F	Convection	Ta = 20°C or less	5years	5years
		Ta = 30°C	5years	3years
A,B,C,D,E,F	Forced air	Ta = 60°C	5years	3years

Table 3.24 Warranty (LFA100F-□)

Mounting Method	Cooling Method	Average ambient temperature (year)	Warranty	
			Io ≤ 75%	75% < Io ≤ 100%
A	Convection	Ta = 40°C or less	5years	5years
		Ta = 50°C	5years	3years
B, C	Convection	Ta = 35°C or less	5years	5years
		Ta = 45°C	5years	3years
D, E, F	Convection	Ta = 25°C or less	5years	5years
		Ta = 35°C	5years	3years
A,B,C,D,E,F	Forced air	Ta = 60°C	5years	3years

Table 3.25 Warranty (LFA150F-□)

Mounting Method	Cooling Method	Average ambient temperature (year)	Warranty	
			Io ≤ 75%	75% < Io ≤ 100%
A	Convection	Ta = 30°C or less	5years	5years
		Ta = 40°C	5years	5years
B	Convection	Ta = 25°C or less	5years	5years
		Ta = 35°C	5years	5years
C	Convection	Ta = 25°C or less	5years	5years
		Ta = 35°C	5years	3years
D, F	Convection	Ta = 25°C or less	5years	5years
E	Convection	Ta = 25°C or less	5years	3years
A,B,C,D,E,F	Forced air	Ta = 60°C	5years	3years

Table 3.26 Warranty (LFA240F-□)

Mounting Method	Cooling Method	Average ambient temperature (year)	Warranty	
			Io ≤ 75%	75% < Io ≤ 100%
A	Convection	Ta = 30°C or less	5years	5years
		Ta = 40°C	5years	3years
B, C	Convection	Ta = 20°C or less	5years	5years
		Ta = 30°C	5years	3years
D, F	Convection	Ta = 20°C or less	5years	3years
E	Convection	Ta = 15°C or less	5years	3years
A,B,C,D,E,F	Forced air	Ta = 60°C	5years	3years

Table 3.27 Warranty (LFA300F-□)

Mounting Method	Cooling Method	Average ambient temperature (year)	Warranty	
			Io ≤ 75%	75% < Io ≤ 100%
A	Convection	Ta = 30°C or less	5years	5years
		Ta = 40°C	5years	3years
B, C	Convection	Ta = 20°C or less	5years	5years
		Ta = 30°C	5years	3years
D	Convection	Ta = 25°C or less	5years	3years
E, F	Convection	Ta = 20°C or less	5years	3years
A,B,C,D,E,F	Forced air	Ta = 50°C	5years	3years

## 4 Ground

■ When installing the power supply with your unit, ensure that the input FG terminal of CN1 or mounting hole FG is connected to safety ground of the unit.

## 5 Option and Others

### 5.1 Outline of options

\* Please inquire us for details of specifications and delivery timing.  
 \* You can combine multiple options. Some options, however, cannot be combined with other options. Please contact us for details.

● -C

· Option -C units have coated internal PCB for better moisture resistance.

● -G

- Option -G units are low leakage current type.
- Differences from standard versions are summarized in Table 5.1.

Table 5.1 Low leakage current type

Leakage Current (AC240V 60Hz)	0.15mA max
Conducted Noise	N/A
Output Ripple Noise	Please contact us for details about Ripple Noise

\* This is the value that measured on measuring board with capacitor of 22μF at 150mm from output connector.  
Measured by 20MHz oscilloscope or Ripple-Noise meter (Equivalent to KEISOKU-GIKEN:RM-103).

● -H (LFA100F-24, LFA150F-24, LFA240F-24, LFA300F-24/30/36/48-TY)

- Option -H units can output the peak current.
- Peak load is possible to draw as below.

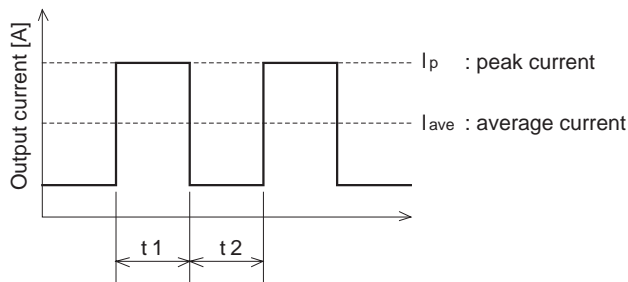

Fig.5.1 Peak current

Input voltage is AC90V to AC264V.

$t1 \leq 10[\text{sec}]$

$I_p \leq \text{rated peak current}$

$I_{ave} \leq \text{rated output current}$

$$\text{Duty} = \frac{t1}{t1+t2} \times 100[\%] \leq 35\%$$

In case of LFA300F duty is depended on peak wattage.

Please contact us about the detail.

Remarks:

\*There is possibility that an internal device is damaged when the specification is exceeded.

● -J (LFA300F)

- Option -J units, the input and output connector are changed to EP connectors (Mfr. Tyco Electronics).
- The appearance in option -J units is different from the standard units. Please contact us about the detail.

● -J1

- Option -J1 units, the Input and Output connector is VH connectors (Mfr. J.S.T.).
- LFA300F appearance of option -J units is different from the standard appearance. Please contact us about the detail.

● -S · -SN

- S indicates a type with chassis, and -SN indicates a type with chassis and cover (Refer to external view). Refer to “Derating Curves” in Section 3.2.
- Please contact us about the detail of LFA300F.

● -SNF (LFA300F-5/12/24-TY)

- In option -SNF, the cover, chassis and cooling fan are added.
- The appearance of option -J units is different from the of standard appearance. Please contact us about the detail.
- Oil and other chemical liquid splashing environment may cause the performance degradation and failure.

● -Y

- Option -Y units can adjust the output voltage by the potentiometer is attached.
- Refer to the adjustable range to the table 5.2 and table 5.3.

■ LFA10F, LFA15F, LFA30F, LFA50F, LFA75F

Table 5.2 Output voltage adjustment range

	Output voltage adjustment range[V]
3.3V*	2.85 to 3.63
5V	4.5 to 5.5
12V	10.8 to 13.2
15V	13.5 to 16.5
24V	21.6 to 26.4
36V	32.4 to 39.6
48V	43.2 to 52.8

\* Some of the product, -Y is standard equipment.

(LFA10F-3R3-Y, LFA15F-3R3-Y, LFA30F-3R3-Y, LFA50F-3R3-Y, LFA75F-3R3-Y)

■ LFA100F, LFA150F, LFA240F, LFA300F

Table 5.3 Output voltage adjustment range

	Output voltage adjustment range[V]
3.3V*	2.85 to 3.63
5V*	4.5 to 5.5
12V	10.8 to 13.2
15V	13.5 to 16.5
24V	21.6 to 27.5
36V	32.4 to 39.6
48V	39.6 to 52.8

\* Some of the product, -Y is standard equipment.

(LFA100F-3R3-Y, LFA100F-5-Y, LFA150F-3R3-Y, LFA150F-5-Y, LFA300F-□-TY)

- To increase an output voltage, turn a built-in potentiometer clockwise.
- To decrease the output voltage, turn it counterclockwise.
- Please take care when you adjust output voltage by potentiometer, because there is possibility of electric shock and the breakdown as contacting to other internal circuit by electrically conductive tool.

### ● -R (LFA100F, LFA150F, LFA240F, LFA300F)

- You can control output ON/OFF remotely in Option -R units. To do so, connect an external DC power supply and apply a voltage to a remote ON/OFF connector, which is available as option.

Model Name	Built-in Resistor Ri [Ω]	Voltage between RC (+) and RC (-) [V]		Input Current [mA]
		Output ON	Output OFF	
LFA100F, LFA150F, LFA240F, LFA300F	780	4.5 - 12.5	0 - 0.5	20max

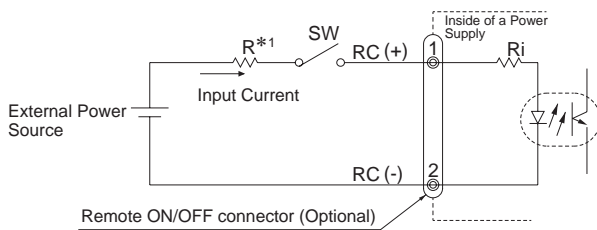

Fig.5.2 Example of using a remote ON/OFF circuit

- Dedicated harnesses are available for your purchase. Please see Optional Parts for details.

\*1 If the output of an external power supply is within the range of 4.5 - 12.5V, you do not need a current limiting resistor R. If the output exceeds 12.5V, however, please connect the current limiting resistor R.

To calculate a current limiting resistance value, please use the following equation.

$$R[\Omega] = \frac{V_{cc} - (1.1 + R_i \times 0.005)}{0.005}$$

\*Please wire carefully. If you wire wrongly, the internal components of a unit may be damaged.

■ Remote ON/OFF circuits (RC+ and RC-) are isolated from input, output and FG.

### ● -R2 (LFA100F, LFA150F, LFA240F, LFA300F)

- The usage is the same as option -R, please refer to Option -R.
- Reducing standby power is possible by OFF signal of the remote control.
- Start up time by ON signal in remote control is 350ms(typ).
- The latch condition in overvoltage protection is removed by toggling ON/OFF signal of remote control.
- Standby power  
LFA100F, LFA150F, LFA240F  
0.2Wtyp (AC100V), 0.7Wtyp (AC200V)  
LFA300F  
0.25Wtyp (AC100V), 1.1Wtyp (AC200V)

### ● -T (LFA240F, LFA300F)

- Option -T units have vertically positioned screws on a terminal block.
- Please contact us for details about appearance.

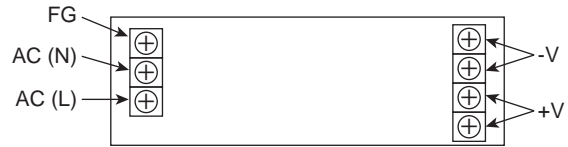

Fig.5.3 Example of option -T

■ The screw can be held to terminal block by inserting and lifting the screwdriver from the side of terminal block.

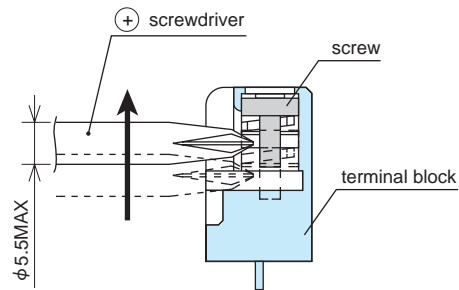

Fig.5.4 lifting method

### ● -T1 (LFA300F)

- Option -T units have horizontally positioned screws on a terminal block.
- Please contact us for details about appearance.

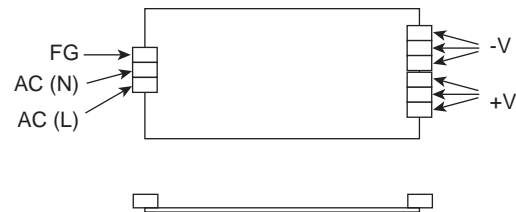

Fig.5.5 Example of option -T1

## 5.2 Others

■ This power supply is the rugged PCB type. Do not drop conductive objects in the power supply.

■ At light load, there remains high voltage inside the power supply for a few minutes after power OFF.

So, at maintenance, take care about electric shock.

■ This power supply is manufactured by SMD technology. The stress to PCB like twisting or bending causes the defect of the unit, so handle the unit with care.

- Tighten all the screws in the screw hole.
- Install it so that PCB may become parallel to the clamp face.
- Avoid the impact such as drops.

- While turning on the electricity, and for a while after turning off, please don't touch the inside of a power supply because there are some hot parts in that.
- When a mass capacitor is connected with the output terminal (load side), the output might become the stop or an unstable operation. Please contact us for details when you connect the capacitor.

### ● LFA10F, LFA15F

- When these power supplies are connected to the input terminal in parallel, the total capacitance between line and line becomes big. Therefore, the electrical discharge resistance on the safety standard might become necessary. Please contact us for details when safety standard is necessary at multiple units usage.